

# INSTALLATION AND OPERATION INSTRUCTIONS

## 24", 30" and 36" Belt Driven Fan and Automatic Shutter

### Whole House Ventilation System



P.O. BOX 4973, CRS  
JOHNSON CITY,  
TN 37602-4973

**corporation**  
America's Comfort Conditioning Company

#### READ AND SAVE THESE IMPORTANT SAFETY AND OPERATING INSTRUCTIONS FOR FUTURE REFERENCE.

**WARNING:** To avoid fire, shock and serious injury read and follow these instructions before installing, using or servicing the fan

**CAUTION:** The fan motor may be equipped with a manual reset protector. Disconnect power supply before resetting

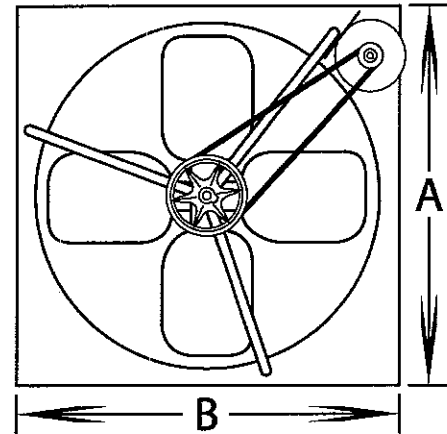
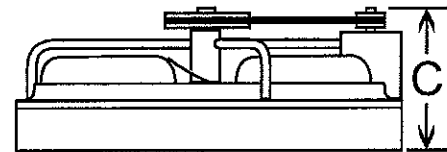

Figure 1



#### Fan Specifications:

Model No.	Blade Size	Motor HP	A	B	C
BD24 - *WH	24	1/3	28	29-1/2	14-1/8
BD30 - *WH	30	1/3	34	35-1/2	14-1/8
BD36 - *WH	36	1/3	40	41-1/2	14-1/8

\* 1 Indicates a single speed motor

\* 2 Indicates a two speed motor

- 1 To operate properly the fan must be installed correctly and have adequate intake and exhaust area. To install it you must know how to use the necessary tools and equipment and understand electrical wiring and the potential hazards. If uncertain in any of these areas please consult a professional.
- 2 To avoid injury always disconnect electric power to fan at fuse box or circuit breaker before working on or cleaning the fan or its controls.
- 3 All wiring must conform to the National Electrical code and applicable local codes. The electrical installation should be approved by a licensed electrician.
- 4 This fan must be connected to a 120 volt 60 HZ grounded circuit only. Do not use an extension cord.
- 5 The fan should be supplied by an individual 15 amp protected circuit so that it may be disconnected for servicing and during winter months when it may be covered to prevent heat loss.
- 6 **Warning:** To reduce the risk of fire or electric shock, do not use any solid-state speed control device with these fans. A 2-Speed wall switch (\*2SW) is provided with fan.
- 7 If a thermostat is used to control the fan, a manual timer or other switch with an "OFF" position must also be connected in the circuit to assure that the fan will not automatically cycle on while the house is closed.
- 8 The fan has an unguarded fan blade and is intended for use in locations not really accessible. If fan is likely to be accessible by people or animals, make guard of wire mesh screen supported over a frame, which will assure a 4 inch clearance from the fan blades and belt.
- 9 **ALWAYS INSTALL THE FAN BEHIND AUTOMATIC SHUTTERS FOR PROTECTION FROM BODILY INJURY AND FROM RAIN IF IT IS INSTALLED ON A WALL.**
- 10 Do not operate this fan without first opening house doors or windows to provide adequate ventilating air intake. Inadequate intake area may impair flue gas ventilation of gas or oil fired equipment. Flames and soot may be drawn into the house.
- 11 Do not operate the fan in an attic where gas or oil filled equipment is in operation as it may interfere with flue gas ventilation.

**PLEASE READ ALL INSTRUCTIONS BEFORE STARTING INSTALLATION OF YOUR NEW FAN. THESE INSTRUCTIONS WILL AID WITH THE INSATALLATION AND WILL HELP ASSURE SATISFACTORY OPERATION OF YOUR WHOLE HOUSE VENTILATION SYSTEM.**

**SELECTING THE LOCATION**

1. Generally the best place in the house to install a whole house attic fan is in a centrally located hallway. REMEMBER that free passage of air from the fresh air intake, through open windows or doors, to the fan, is necessary during operation. If the fan is located in a room, the door to the room must remain open anytime the fan is operating. (See Fig 2)
2. Also check that attic clearance above the fan to the roof is adequate – a minimum of fan blade diameter from top of joist to rafter is needed above the fan at the lowest side. (See Fig. 3)
3. Check to be sure there are no obstructions such as electrical wiring, air ducts, or support beams in the attic above the selected fan location. Partitions or a chimney, etc in the attic adjacent to the fan may reduce fan efficiency and increase noise
4. Be sure the hallway is wide enough for the shutter being used. Note that for a “no joist cut” installation the shutter blades must be oriented parallel with the joists so they may open up into the space between joists. The hallway must be at least 30” wide for SL-24W shutter, 36” wide for SL-30W shutter, and 42”wide for SL-36W SHUTTER, if the ceiling joists run across (perpendicular to) the hall. If they run parallel with the hallway then a joist must be located at least 16” from both walls to be used as the joist through the center of the opening. If neither of the above is the case then choose a new fan location or use joist cut type installation.
5. Adequate exhaust area from the attic must be provided.  
 Fan model BD24 requires 7 square feet minimum.  
 Fan model BD30 requires 9 square feet minimum.  
 Fan model BD36 requires 12 square feet minimum.

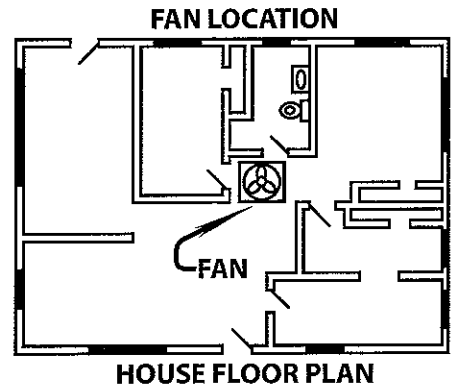

Figure 2

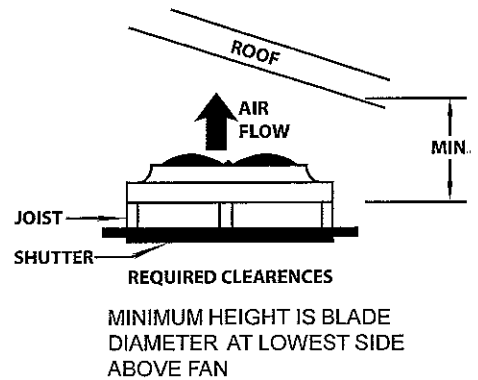

Figure 3

**INSTALLATION**

FOR NO JOIST CUT “DO IT YOURSELF” INSTALLATION USING THE SL SERIES SHUTTER LISTED IN THE SPECIFICATIONS. (See Fig. 4)

**Automatic Ceiling Shutters**

Model No.	SIZE		OPENING	
	W	L	W	L
SL-24W	28	X 29 3/4	27	X 28 1/2
SL-30W	32 1/8	X 35 5/8	30 1/2	X 34 1/2
SL-36W	32 1/8	X 41 5/8	30 1/2	X 40 1/2

These shutters may be used for either joist cut or no joist cut type of installation.

**NOTE:** Suffix S on fan model number indicates shutter packed with fan.

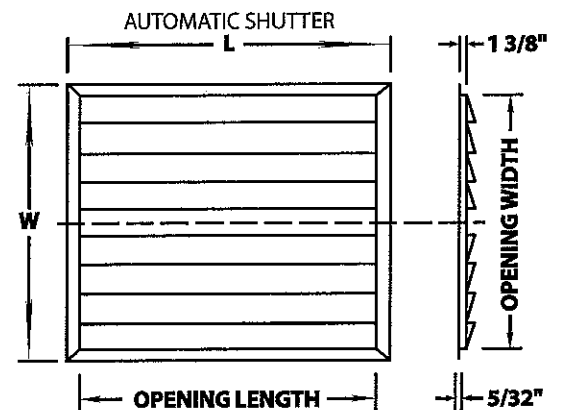

Figure 4

**CAUTION: ALWAYS WEAR SAFETY GOGGLES COMPLYING WITH ANSI 287.1 WHEN DRILLING OR CUTTING.**

**NOTE: Before cutting the ceiling double check all dimensions. REMEMBER: The ceiling opening is sized to fit the shutter, not the fan**

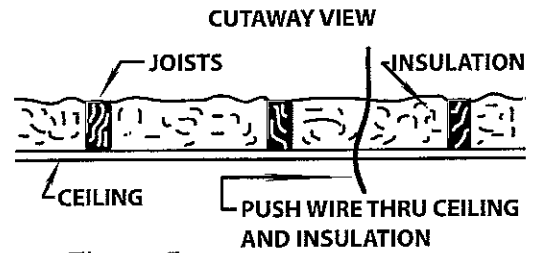

Figure 5

1. As an aid in locating, in the attic, the general area of the hole to be cut, a piece of wire, such as a straightened coat hanger, may be pushed up through ceiling near the center of the planned opening (relocate a few inches if it hits a joist). It should extend up through the attic insulation far enough to be easily located in the attic (See Fig. 5).

2. After locating the wire in the attic, review the area for obstructions etc. discussed earlier, and for direction of joist run in relation to the hallway (not critical if installed in a room) If the area is suitable, select a joist on which the fan and shutter will center. Remove insulation from the area and save for use around fan installation (See Fig. 6)

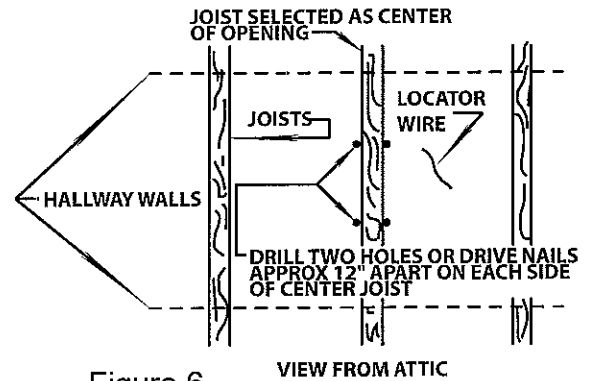

Figure 6

3. The location of this center joist must be accurately transferred to the ceiling below. This may be done by pushing two nails down through the ceiling about 12" apart along each side of the joist well within the area to be cut (See Fig. 6).

4. From the hallway locate the four nails which locate the joist position. Draw a straight line between the two nails on each side of the joist and extending out beyond the planned hole size (See Fig. 7)

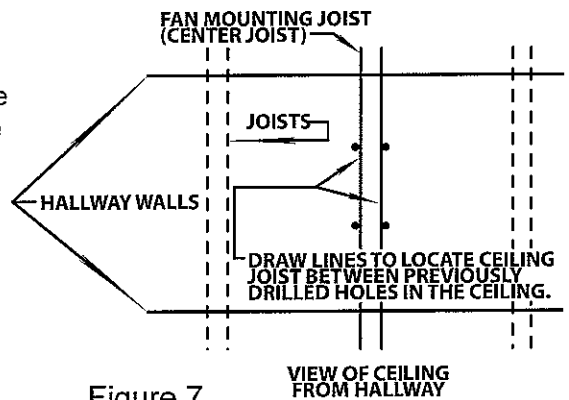

Figure 7

5. Open one end of the fan carton and remove fan and shutter together (if packaged together), **being careful not to damage the shutter, protect the motor shaft from impact.** Separate shutter from fan. Check for damage and that fan turns freely.

6. Make a template for the shutter, to properly position the ceiling opening in relation to the joist on which the fan is to be mounted. Mark joist location lines on the template under the ceiling joist (See Fig. 8). Note that the ceiling opening for the 24" fan is off center of the mounting joist

7. **NOTE:** Use the shutter to check the opening size for accuracy. The edge of the opening must be at least 7/8" from the wall or any other obstruction on the ceiling. Cut the sheetrock along the marked outline and remove. Be careful not to cut the joist.

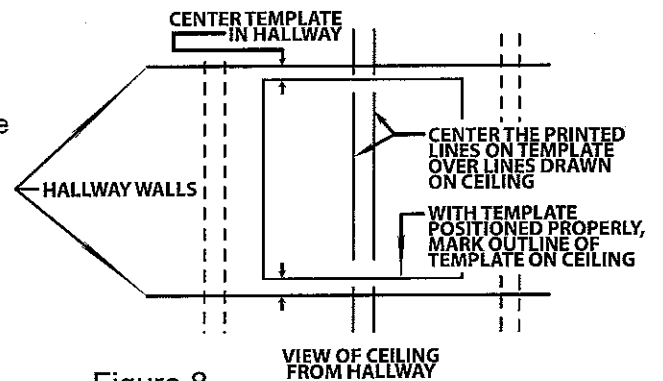
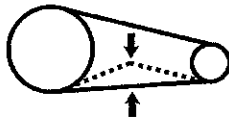

Figure 8

8. Lift the fan through the opening into the attic being careful not to damage the sheetrock. Set fan on the joist, centered over the opening per Fig 10. When mounting the fan on joists spaced too wide to support the corner of the venturi under the motor, nail a header between the two joists located to support this corner of the fan.
9. Cut and/or notch skirt material as necessary to fit around the wood plenum enclosing the area between the fan and the ceiling. Use duct tape to seal all joists and seams to assure fan efficiency. Replace insulation around the fan plenum (See Figure 12)

(NOTE: Install the belt by placing on motor pulley and rolling onto the large pulley, belt tension should be  $5/8" - 3/4"$  when deflected, measured from outside edge of belt, one side only)



10. Following all applicable electrical codes, bring supply wire to wiring compartment of the fan. On models with suffix "x" this will be a switch box mounted to frame. All others connect directly to the motor terminals. Make connections per the appropriate wiring diagram Figures 13, 14 and 15. If a pull chain switch is installed on the two speed fan, but a wall mounted speed selector switch is to be installed, use switch model 2SW. Disconnect the motor leads from the pull chain switch and connect to wiring from wall mounted switch per diagram Figure 13. Recommended minimum wire size is 14-2 with ground for up to 50 feet and 12-2 with ground if longer than 50 feet.

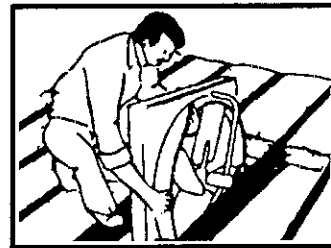

Figure 9

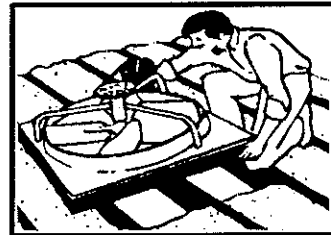

Figure 10

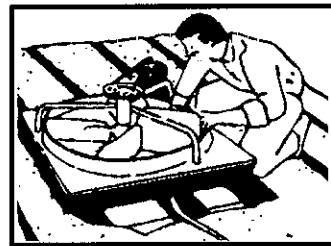

Figure 12

**WARNING:** Turn off all electric power to the fan at control panel (remove fuse or disconnect circuit breaker before making any line voltage connections). Wiring must comply with local and national electrical codes. Wiring should be installed or approved by a licensed electrician.

- 11 From the hallway install the shutter per instructions supplied with the shutter.

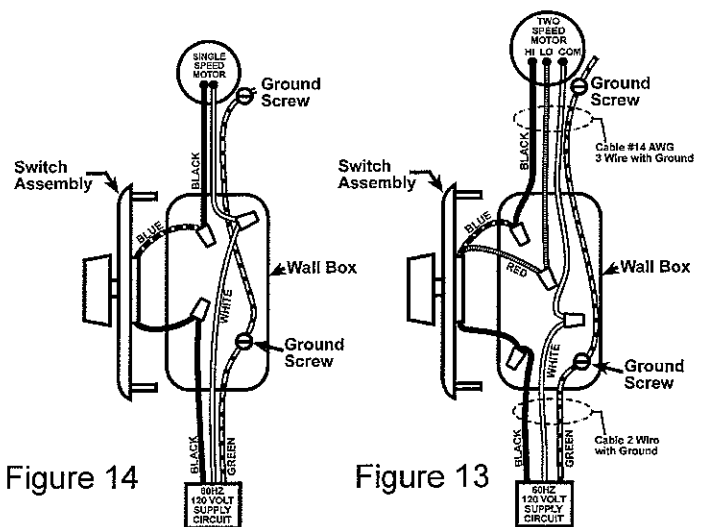
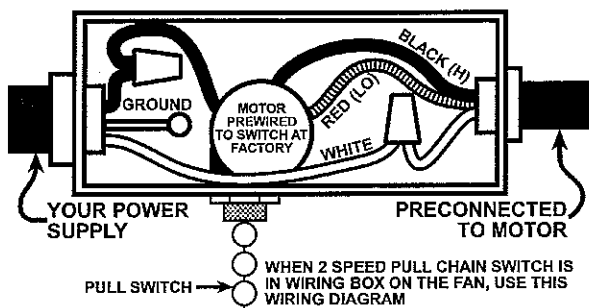

Figure 14

Figure 13

DIAGRAM FOR SINGLE SPEED MOTOR USING WALL MOUNTED SWITCH MODEL 1SW (OPTIONAL ACCESSORY)

DIAGRAM FOR TWO SPEED MOTOR USING WALL MOUNTED SWITCH MODEL 2SW SUPPLIED WITH FAN

**WARNING:** To reduce the risk of fire or electric shock do not use any solid state speed control device with fan

## FOR JOIST CUT INSTALLATION

### CS Series Automatic Ceiling Shutters Specifications

Model No.	Fits Hole Size (I.D.)		Outside Size (O.D.)		Fan Size	No. Of Blades
	L	W	L	W		
CS-10	26	26	28	28	24"	6
CS-13	32	34	34	36 3/8	30"	8
CS-14	34	34	36	36 3/8	30"	8
CS-18	32	42	34	44 1/2	36"	10
CS-19	34	42	36	44 1/2	36"	10
CS-22	34	50	36	52 5/8	42"	12

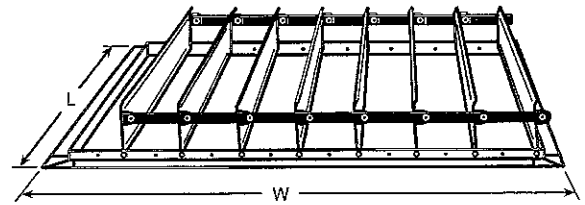

Model CS-14 Shown

1. First check the ceiling shutter being used to determine the size of the required ceiling opening. This should be specified by instruction or a template supplied with the shutter. Note that either the CS series shutter or the SL series of Figure 4 may be used for this type of installation.
2. The opening may begin at a joist and extend in width as required. The opening should be framed using joist sized lumber with the inside of the framed opening being the size required for the shutter used. Discard the skirts and joist brackets supplied with this fan.
3. Before cutting a joist in a finished ceiling we suggest cutting and removing the sheetrock from the shutter opening, then framing the opening between joists and at the side with joist sized lumber extending to and nailed to the adjoining joists as shown in Figure 15.
4. Build a platform around the top of the framed opening using at least 1" X 4" lumber nailed to the frame and joist (See Figure 16). It must extend wide enough to support all edges of the fan plenum creating an air seal and forming a duct from the living space to the fan thus assuring the air is drawn only from the home below, maximizing fan effectiveness. Then the joist(s) across the opening may be cut flush with the edge of the opening (Figure 17).
5. Lift fan through opening into attic and place it on the platform centered over the opening. A good method of securing the fan in location is to drive nails part way into platform beside the plenum, two per side (See Figure 18).
6. Route electric supply wire to the fan wiring box and connect per Figure 13, 14, 15, as appropriate. Reference paragraph 11 of previous section.
7. From the hallway install the shutter per instructions supplied with the shutter.

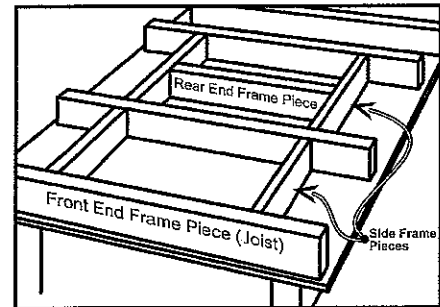

Figure 15

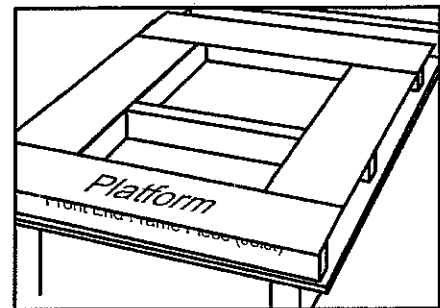

Figure 16

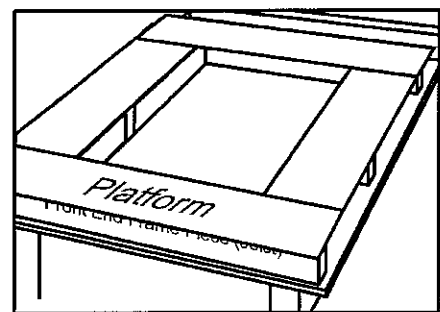

Figure 17

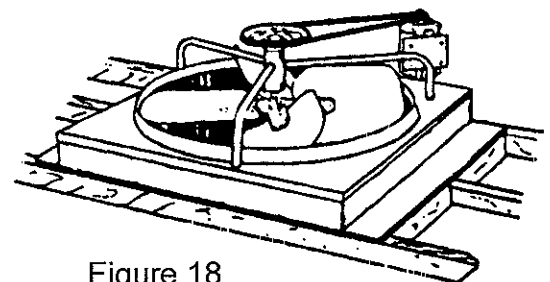

Figure 18

## FAN OPERATION

In order to maximize the cooling and ventilating effect of your new attic fan, it must be operated properly.

**First and Foremost:** Never operate your fan without first opening enough doors or windows to supply sufficient intake air. Initially you should vary the levels of opening, in order to satisfy your particular needs. Experiment and you'll soon learn how to manipulate the airflow throughout your living area. Zone the air to where the occupants are in the home.

**When to use your attic fan** (hours of the day etc.) Many factors can influence this decision. However, a good rule of thumb is to use your attic fan whenever the outside temperature is 85° or less. Some of the factors that can vary this include: humidity, mean radiant heat, thermal effect, barometric pressure. Again, we strongly recommend that you experiment. Use your fan in the early morning hours of a hot summer day to sub-cool your living area. The lower you can get the inside temperature early in the day the greater the cooling efficiency. Then when the outside temperature starts to climb stop the fan and close all doors and windows and you will notice a delay in time before your air conditioning is needed (increasing energy savings). Under ideal climate conditions, you may not need your air conditioning at all. This will not only help you save energy but will help extend the life of your air conditioning unit.

## ROUTINE SERVICE

1. For your safety, disconnect the electric power before performing any service on the fan.
2. At the end of the fan use season we suggest that the fan belt be removed. This is to prevent the belt taking a set shape around the small pulley during extended periods of non use which may cause a belt bump noise when restarted in the spring. It may be removed by rolling it off of the large pulley first.
3. Annually clean the shutters, fan and motor.
4. Annually check that attic ventilators are not blocked reducing air flow.

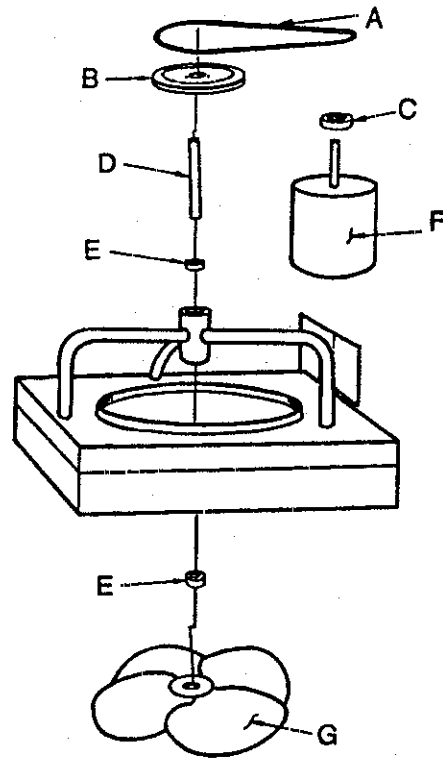

## REPAIR PARTS LIST

DWG. REF.#	QTY.	PART	FAN MODELS					
			BD24-1WH	BD24-2WH	BD30-1WH	BD30-2WH	BD36-1WH	BD36-2WH
A	1	V-BELT	4L X 48" 40361-012	4L X 48" 40361-012	4L X 55" 40361-013	4L X 55" 40361-013	4L X 60" 40361-006	4L X 60" 40361-006
B	1	BLADE PULLEY ¾" BORE	4L X 7" 50201-002	4L X 7" 50201-002	4L X 8" 50201-005	4L X 8" 50201-005	4L X 8" 50201-005	4L X 8" 50201-005
C	1	MOTOR PULLEY ½" BORE	4L X 2 ½" 50202-001	4L X 2 ½" 50202-001	4L X 2 ½" 50202-001	4L X 2 ½" 50202-001	4L X 2" 50202-003	4L X 2" 50202-003
D	1	SHAFT ¾" X 9"	50198-005	50198-005	50198-005	50198-005	50198-005	50198-005
E	2	BEARING ASS'Y ¾" BORE	50200-001	50200-001	50200-001	50200-001	50200-001	50200-001
F	1 1	MOTOR 1 SPEED 2 SPEED	54962-001	54961-001	54962-001	54961-001	54962-001	54961-001
G	1	FAN BLADE	62962-001	62962-001	62962-002	62962-002	62962-003	62962-003
	1 1	WALL SWITCH 1 SPEED 2 SPEED	61181-001	61181-002	61181-001	61181-002	61181-001	61181-002

## READ AND SAVE THESE INSTRUCTIONS

### **WARNING: TO REDUCE THE RISK OF FIRE, ELECTRIC SHOCK, OR INJURY TO PERSONS; OBSERVE THE FOLLOWING:**

- A. Use this unit in the manner intended by the manufacturer. If you have questions, contact the manufacturer.
- B. Before servicing or cleaning unit, switch power off at service panel and lock service panel to prevent power from being turned back on accidentally.

### **WARNING: TO REDUCE THE RISK OF FIRE, ELECTRIC SHOCK, OR INJURY TO PERSONS; OBSERVE THE FOLLOWING:**

- A. Installation work and electrical wiring must be done by qualified persons in accordance with all applicable codes and standards, including fire-rated construction.
- B. The combustion airflow needed for safe operation of fuel burning equipment may be affected by this unit's operation. Follow the heating equipment manufacturer's guidelines and safety standards such as those published by the National Fire Protection Association (NFPA), and the American Society for Heating, Refrigeration and Air Conditioning Engineers (ASHRAE), and the local code authorities.
- C. When cutting or drilling into wall or ceiling, do not damage electrical wiring and other hidden utilities.

### **CAUTION:**

For general ventilating use only. Do not use to exhaust hazardous or explosive materials and vapors.

### **CAUTION:**

This unit has an unguarded impeller. Do not use in locations readily accessible to people or animals.

